

描述 / Descriptions

TO-252 塑封封装 NPN 半导体三极管。Silicon NPN transistor in a TO-252 Plastic Package.

特征 / Features

高的击穿电压，适合用于变压器，无卤产品。

High collector-Emitter breakdown voltage, Suitable for transformer, HF Product.

用途 / Applications

用于普通高压放大。

High voltage general purpose applications.

内部等效电路 / Equivalent Circuit

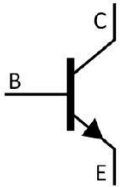

引脚排列 / Pinning

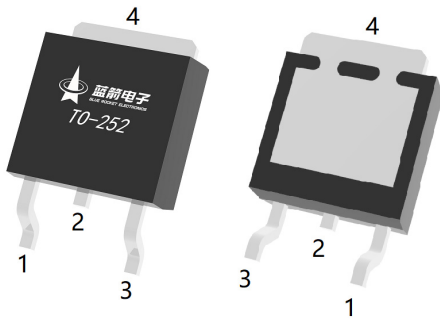

PIN1 : Base

PIN 2,4 : Collector

PIN 3 : Emitter

放大及印章代码 / hFE Classifications & Marking

见印章说明。See Marking Instructions.

极限参数 / Absolute Maximum Ratings(Ta=25°C)

参数 Parameter	符号 Symbol	数值 Rating	单位 Unit
Collector to Base Voltage	V _{CBO}	300	V
Collector to Emitter Voltage	V _{CEO}	300	V
Emitter to Base Voltage	V _{EBO}	5.0	V
Collector Current - Continuous	I _C	500	mA
Collector Power Dissipation	P _C	1.56	W
Collector Power Dissipation	P _C (T _C =25°C)	15	W
Junction Temperature	T _j	150	°C
Storage Temperature Range	T _{stg}	-55~150	°C

电性能参数 / Electrical Characteristics(Ta=25°C)

参数 Parameter	符号 Symbol	测试条件 Test Conditions	最小值 Min	典型值 Typ	最大值 Max	单位 Unit
Collector to Base Breakdown Voltage	V _{CBO}	I _C =0.1mA I _E =0	300			V
Collector to Emitter Breakdown Voltage	V _{CEO}	I _C =1.0mA I _B =0	300			V
Emitter to Base Breakdown Voltage	V _{EBO}	I _E =0.1mA I _C =0	5.0			V
Collector Cut-Off Current	I _{CBO}	V _{CB} =300V I _E =0			100	μA
Emitter Cut-Off Current	I _{EBO}	V _{CE} =3V I _C =0			100	μA
DC Current Gain	h _{FE}	V _{CE} =10V I _C =50mA	30		240	
Collector to Emitter Saturation Voltage	V _{CE(sat)}	I _C =50mA I _B =5.0mA			1.0	V
Base to Emitter Saturation Voltage	V _{BE(sat)}	I _C =50mA I _B =5.0mA			1.2	V

电参数曲线图 / Electrical Characteristic Curve

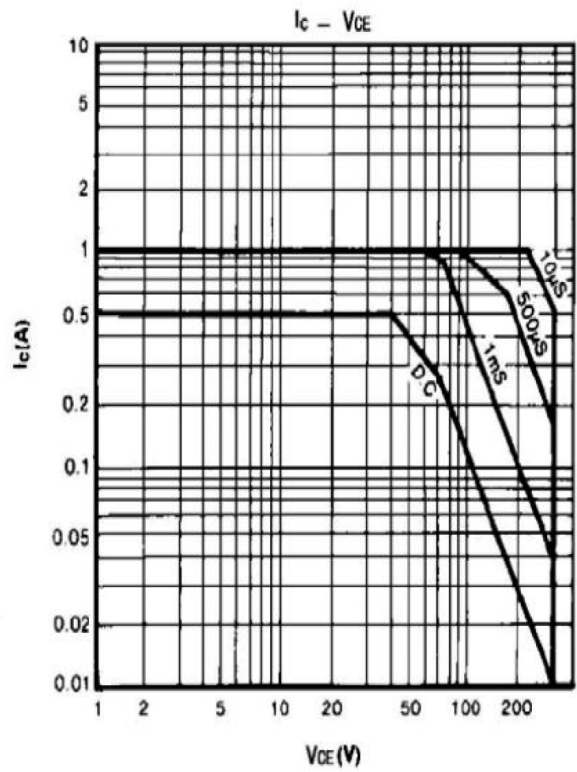
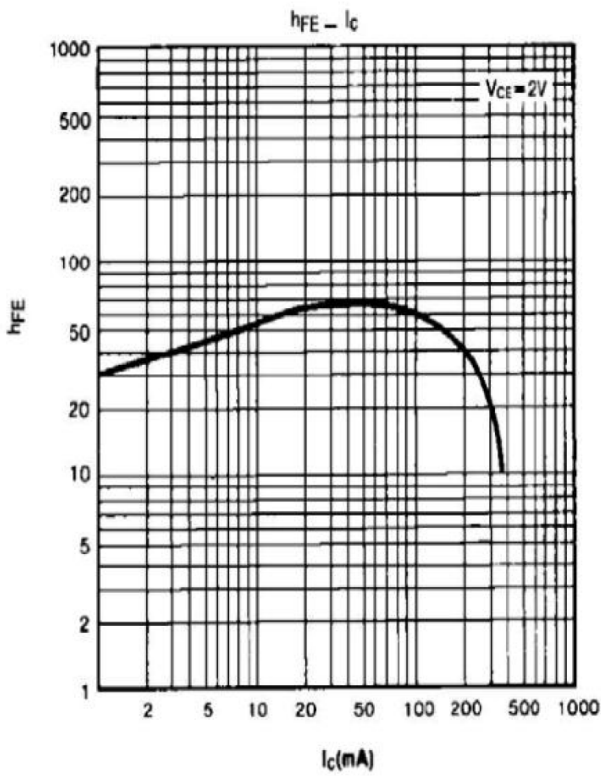
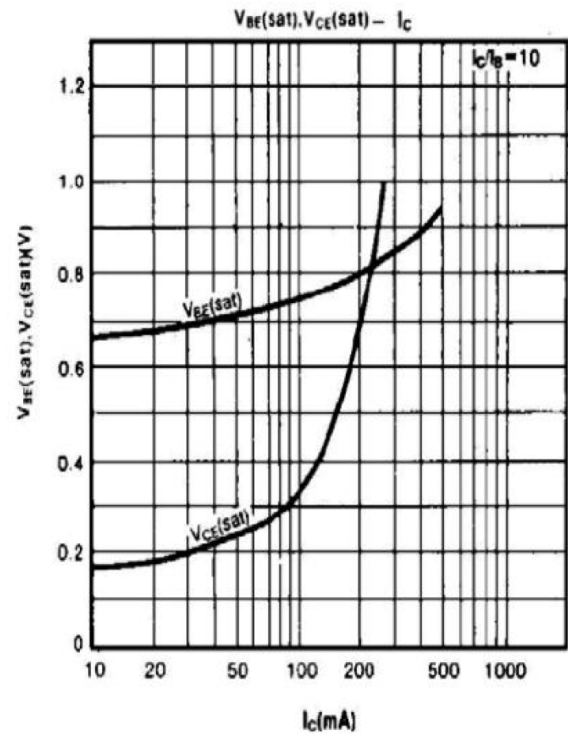
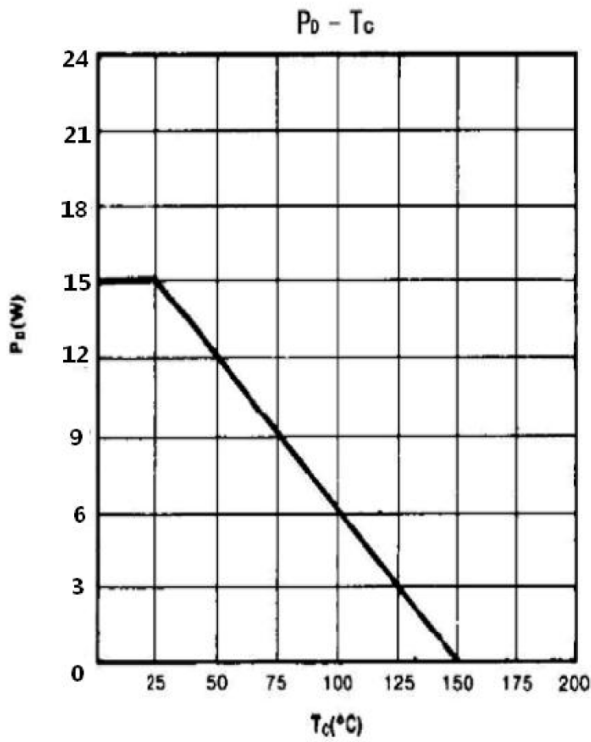

外形尺寸图 / Package Dimensions

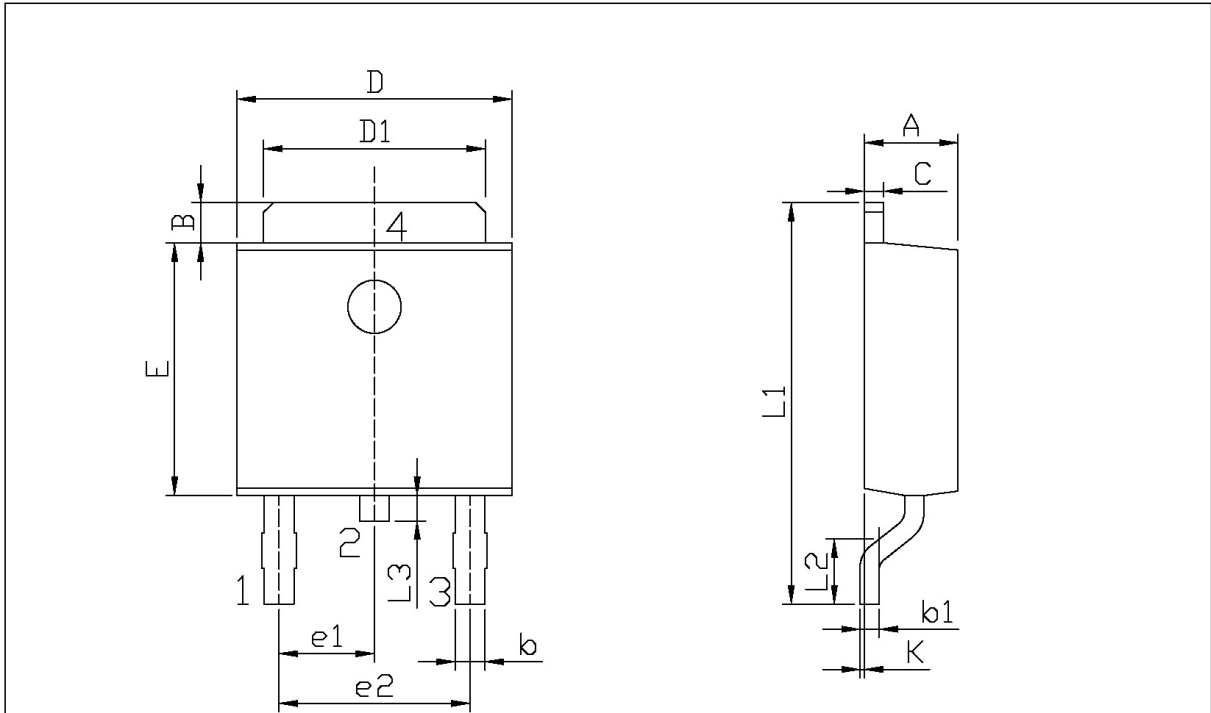

单位: mm

Symbol	Dimensions In Millimeters		Symbol	Dimensions In Millimeters	
	Min	Max		Min	Max
A	2.20	2.40	E	5.95	6.25
B	0.95	1.25	e1	2.24	2.34
b	0.50	0.90	e2	4.43	4.73
b1	0.45	0.55	L1	9.45	9.95
C	0.45	0.55	L2	1.25	1.75
D	6.45	6.75	L3	0.60	0.90
D1	5.10	5.50	K	0.00	0.10

TO-252

印章说明 / Marking Instructions

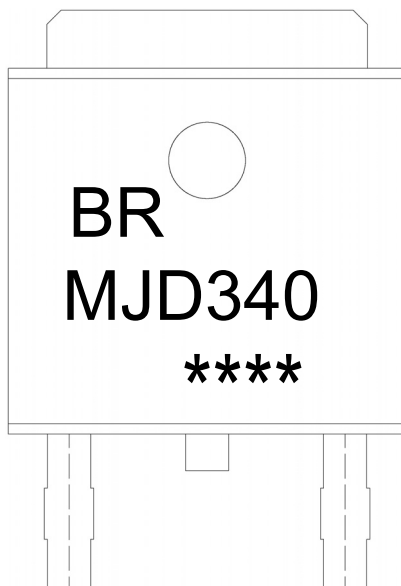

说明：

BR： 为公司代码

MJD340： 为产品型号

****： 为生产批号代码，随生产批号变化

Note:

BR: Company Code

MJD340: Product Type

****: Lot No. Code, code change with Lot No

回流焊温度曲线图(无铅) / Temperature Profile for IR Reflow Soldering(Pb-Free)

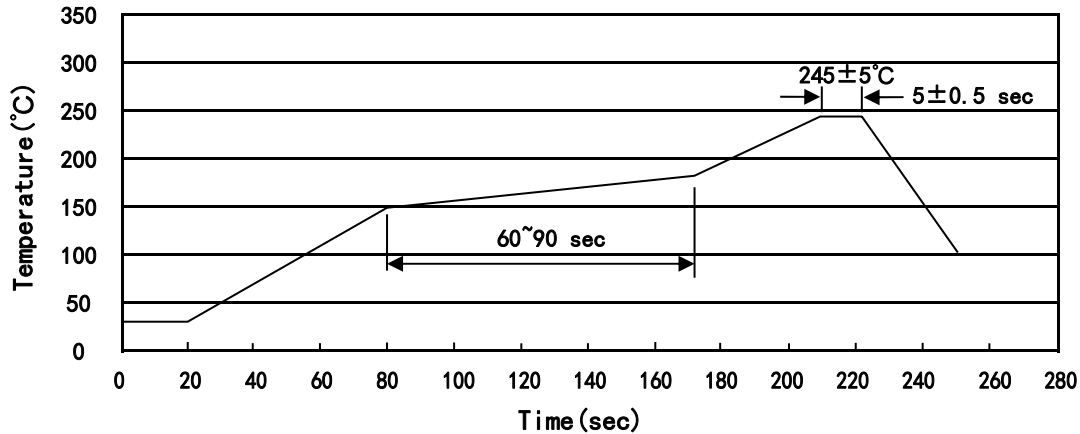

说明：

- 1、预热温度 150~180°C，时间 60~90sec;
- 2、峰值温度 245±5°C，时间持续为 5±0.5sec;
- 3、焊接制程冷却速度为 2~10°C/sec.

Note:

- 1.Preheating:150~180°C, Time:60~90sec.
- 2.Peak Temp.:245±5°C, Duration:5±0.5sec.
3. Cooling Speed: 2~10°C/sec.

耐焊接热试验条件 / Resistance to Soldering Heat Test Conditions

温度：260±5°C 时间：10±1 sec. Temp.:260±5°C Time:10±1 sec

包装规格 / Packaging SPEC.

卷盘包装 / REEL

Package Type 封装形式	Units 包装数量					Dimension 包装尺寸 (unit: mm ³)		
	Units/Reel 只/卷盘	Reels/Inner Box 卷盘/盒	Units/Inner Box 只/盒	Inner Boxes/Outer Box 盒/箱	Units/Outer Box 只/箱	Reel	Inner Box 盒	Outer Box 箱
TO-252	2,500	2	5,000	6	30,000	13" ×16	360×360×50	380×335×366

套管包装 / TUBE

Package Type 封装形式	Units 包装数量					Dimension 包装尺寸 (unit: mm ³)		
	Units/Tube 只/套管	Tubes/Inner Box 套管/盒	Units/Inner Box 只/盒	Inner Boxes/Outer Box 盒/箱	Units/Outer Box 只/箱	Tube 套管	Inner Box 盒	Outer Box 箱
TO-251/252	75	48	3,600	5	18,000	526×20.5×5.25	555×164×50	575×290×180

使用说明 / Notices