

BRCS120N06SZCQ

Rev.A Jul.-2024

描述 / Descriptions

PDFN5×6 封装 N 沟道场效应管。
 N-Channel MOSFET in a PDFN5×6 Plastic Package.

特征 / Features

$V_{DS} (V) = 60V$ $I_D = 43A (V_{GS} = \pm 20V)$

$R_{DS(ON)}@10V \leq 13m\Omega$ (Typ. 11.5m Ω)

$R_{DS(ON)}@4.5V \leq 18m\Omega$ (Typ. 15.5m Ω)

符合 AEC-Q101 标准高可靠性要求，无卤产品。 Qualified to AEC-Q101 Standards for High Reliability, HF Product.

用途 / Applications

次级侧同步整流，DC-DC 变换器，电机控制，负载切换，满足汽车应用的严格要求。

Secondary Side Synchronous Rectification, DC-DC Converter, Motor Control, Load Switching, Meet the stringent requirements of automotive applications.

内部等效电路 / Equivalent Circuit

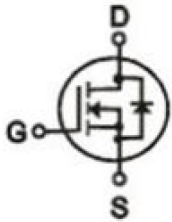

引脚排列 / Pinning

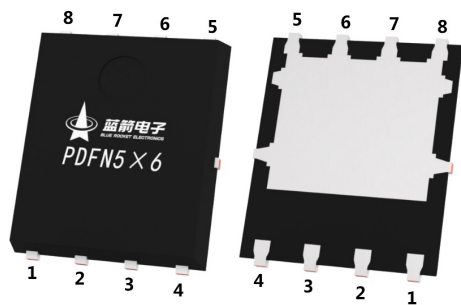

PIN1、2、3: S PIN4: G PIN5、6、7、8: D

Pin	极性
1	S
2	S
3	S
4	G
5	D
6	D
7	D
8	D

印章代码 / Marking

见印章说明。

See Marking Instructions.

极限参数 / Absolute Maximum Ratings($T_a=25^{\circ}\text{C}$)

参数 Parameter	符号 Symbol	数值 Rating	单位 Unit
Drain-Source Voltage	V_{DS}	60	V
Continuous Drain Current	I_D	43	A
Pulsed Drain Current	I_{DM}	111	A
Gate-Source Voltage	V_{GS}	± 20	V
Power Dissipation	$P_D(T_c=25^{\circ}\text{C})$	43	W
Avalanche energy(L=0.5mH)	E_{AS}	200	mJ
Avalanche Current(L=0.5mH)	I_{AS}	20	A
Junction and Storage Temperature Range	T_j, T_{stg}	-55 to 150	$^{\circ}\text{C}$
Maximum Junction-to-Ambient	$t \leq 10\text{s}$	$R_{\theta JA}$	25
	Steady-State		60
Maximum Junction-to-Case	Steady-State	$R_{\theta JC}$	2.9

电性能参数 / Electrical Characteristics($T_a=25^{\circ}\text{C}$)

参数 Parameter	符号 Symbol	测试条件 Test Conditions	最小值 Min	典型值 Typ	最大值 Max	单位 Unit
Drain-Source Breakdown Voltage	BV_{DSS}	$V_{GS}=0\text{V}$ $I_D=250\mu\text{A}$	60	64		V
Zero Gate Voltage Drain Current	I_{DSS}	$V_{DS}=60\text{V}$ $V_{GS}=0\text{V}$			1	μA
Gate-Body Leakage Current Forward	I_{GSS}	$V_{GS}=\pm 20\text{V}$ $V_{DS}=0\text{V}$			± 0.1	μA
Gate Threshold Voltage	$V_{GS(th)}$	$V_{DS}=V_{GS}$ $I_D=250\mu\text{A}$	1.0	1.6	2.5	V
Static Drain-Source On-Resistance	$R_{DS(on)}$	$V_{GS}=10\text{V}$ $I_D=20\text{A}$		11.5	13	$\text{m}\Omega$
		$V_{GS}=4.5\text{V}$ $I_D=10\text{A}$		15.5	18	$\text{m}\Omega$
Drain-Source Diode Forward Voltage	V_{SD}	$V_{GS}=0\text{V}$ $I_S=1\text{A}$			1.2	V
Input Capacitance	C_{iss}	$V_{DS}=25\text{V}$ $V_{GS}=0\text{V}$ $f=1.0\text{MHz}$		1010		pF
Output Capacitance	C_{oss}			250		
Reverse Transfer Capacitance	C_{rss}			280		
Gate resistance	R_g	$V_{GS}=0\text{V}$ $V_{DS}=0\text{V}$ $f=1\text{MHz}$		2.3		Ω
Total Gate Charge	$Q_{g(10V)}$	$V_{GS}=10\text{V}$ $V_{DS}=30\text{V}$ $I_D=13\text{A}$		13.5		nC
Total Gate Charge	$Q_{g(4.5V)}$			6.5		
Gate Source Charge	Q_{gs}			2.5		
Gate Drain Charge	Q_{gd}			3.0		

BRCs120N06SZCQ

Rev.A Jul.-2024



DATA SHEET

电性能参数 / Electrical Characteristics(Ta=25°C)

参数 Parameter	符号 Symbol	测试条件 Test Conditions	最小值 Min	典型值 Typ	最大值 Max	单位 Unit
Turn-On Delay Time	$t_{d(on)}$	$V_{GS}=10V$ $V_{DS}=30V$ $R_L=2.3\Omega$ $R_{GEN}=3\Omega$		5		ns
Turn-On Rise Time	t_r			3		
Turn-Off Delay Time	$t_{d(off)}$			19		
Turn-Off Fall Time	t_f			3		

电参数曲线图 / Electrical Characteristic Curve

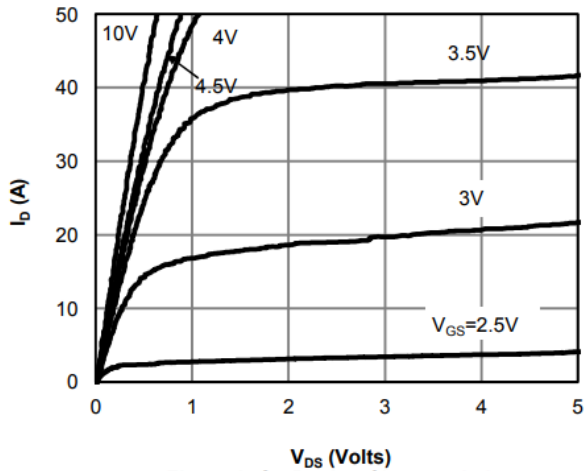

Figure 1: On-Region Characteristics

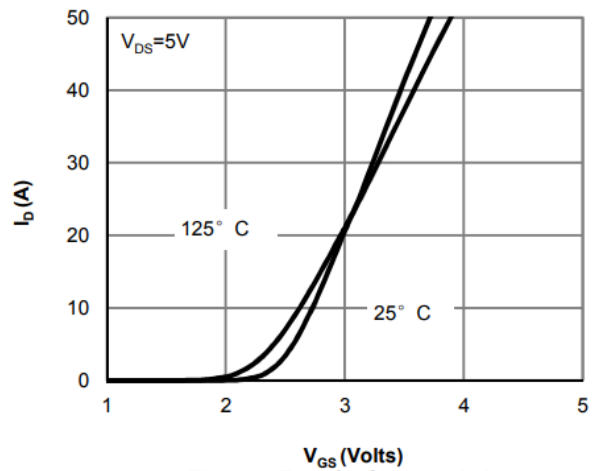

Figure 2: Transfer Characteristics

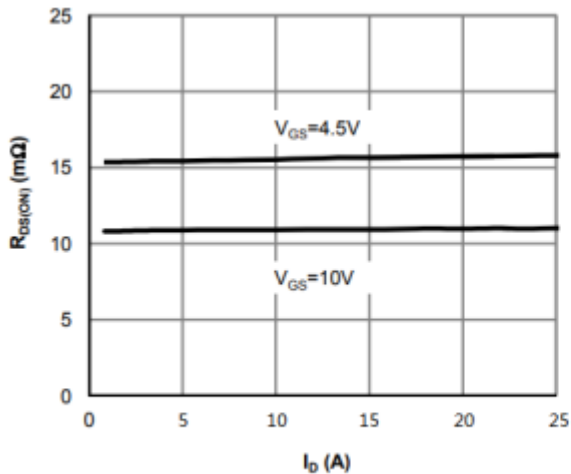

Figure 3: On-Resistance vs. Drain Current and Gate Voltage

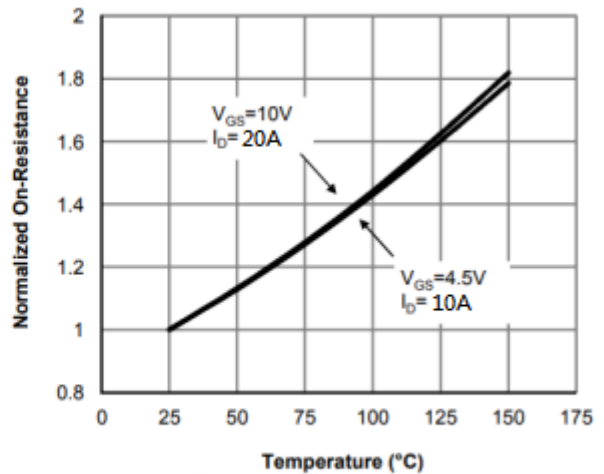

Figure 4: On-Resistance vs. Junction Temperature

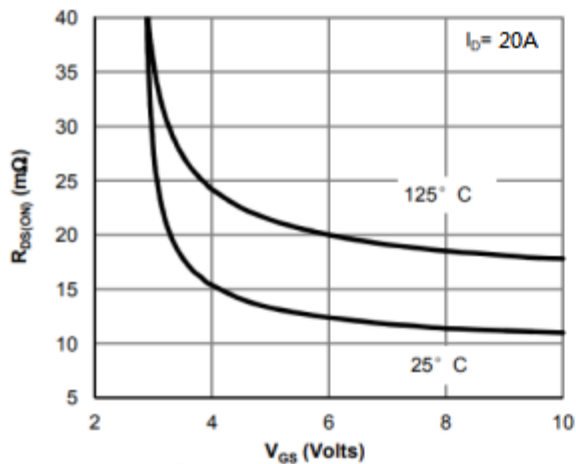

Figure 5: On-Resistance vs. Gate-Source Voltage

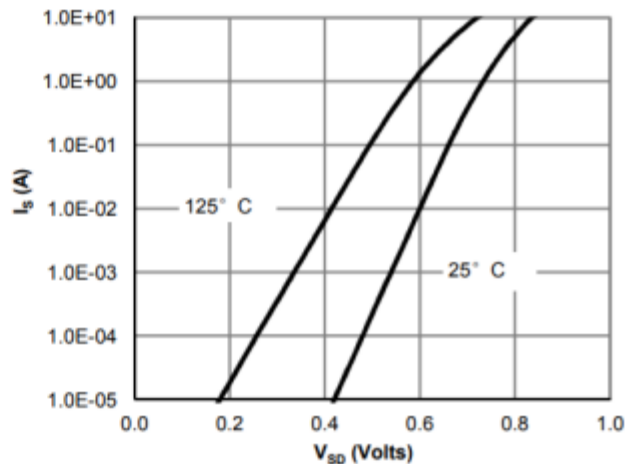

Figure 6: Body-Diode Characteristics

电参数曲线图 / Electrical Characteristic Curve

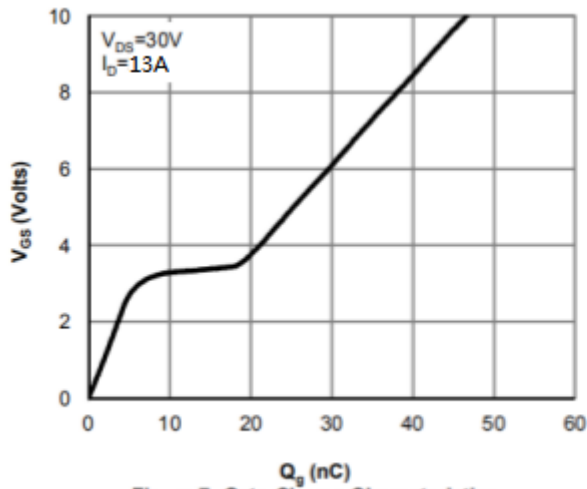

Figure 7: Gate-Charge Characteristics

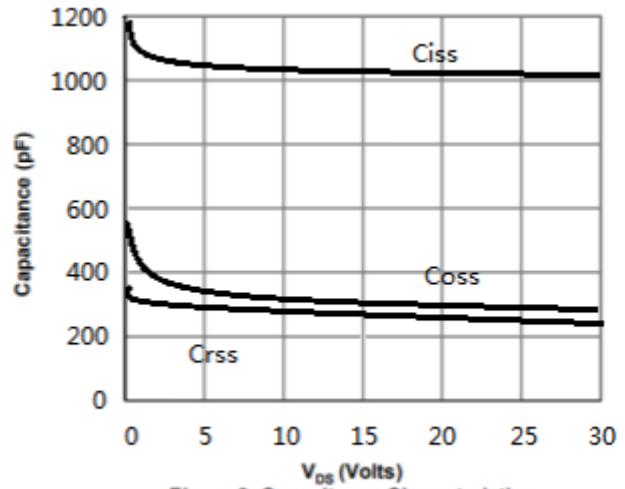

Figure 8: Capacitance Characteristics

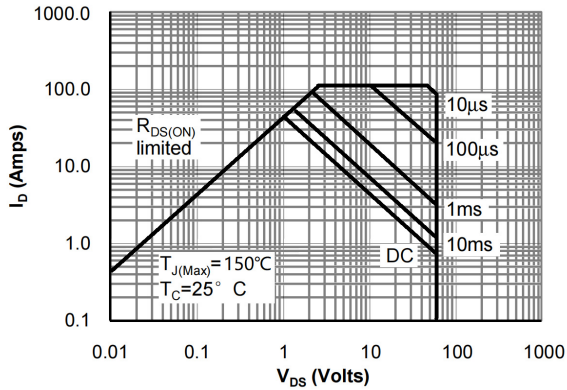

Figure 9: Maximum Forward Biased Safe Operating Area

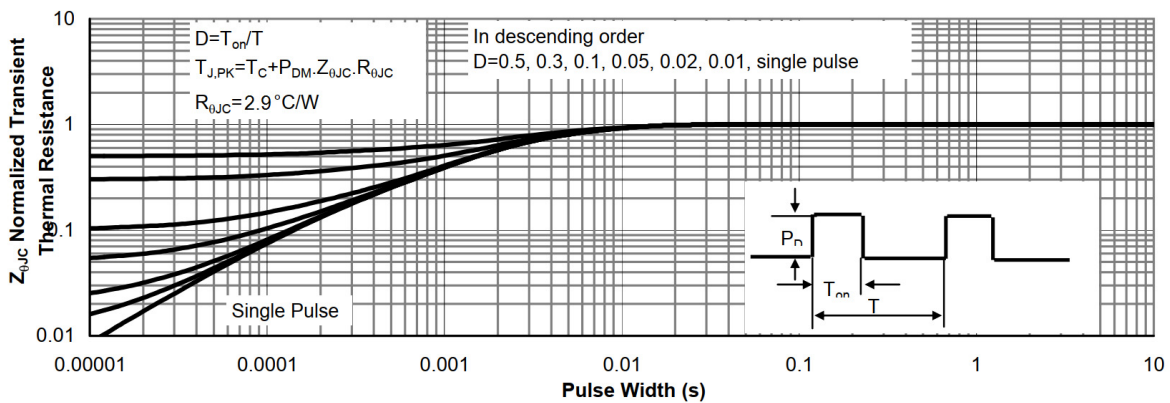
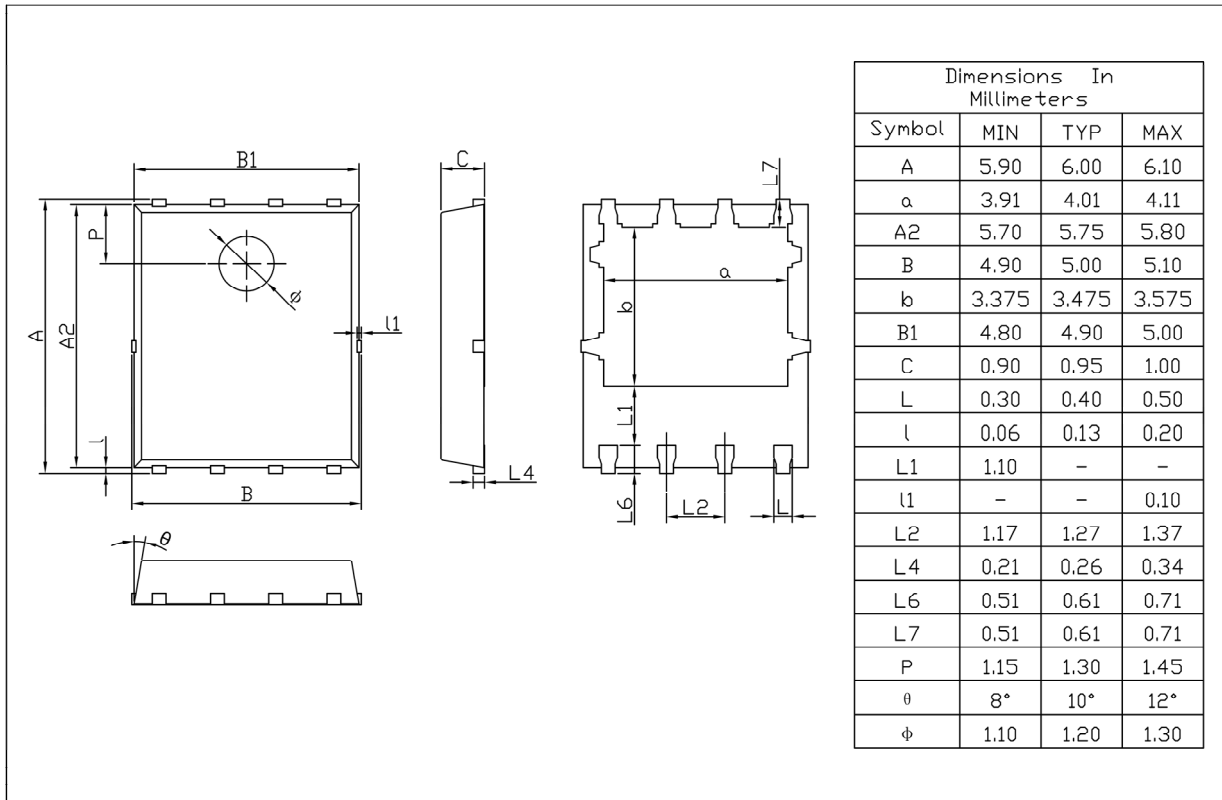

Figure 10: Normalized Maximum Transient Thermal Impedance

外形尺寸图 / Package Dimensions

PDFN5×6

Unit:mm



Rev.01 202209

印章说明 / Marking Instructions

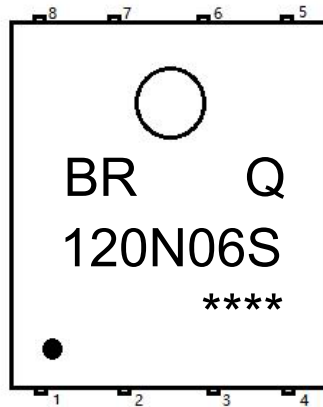

说明：

BR： 为公司代码

Q： 为汽车无卤产品标识

120N06S： 为型号代码

****： 为生产批号代码，随生产批号变化

Note：

BR： Company Code

Q: Automobile halogen-free product Code

120N06S： Product Type Code

****: Lot No. Code, code change with Lot No

回流焊温度曲线图(无铅) / Temperature Profile for IR Reflow Soldering(Pb-Free)

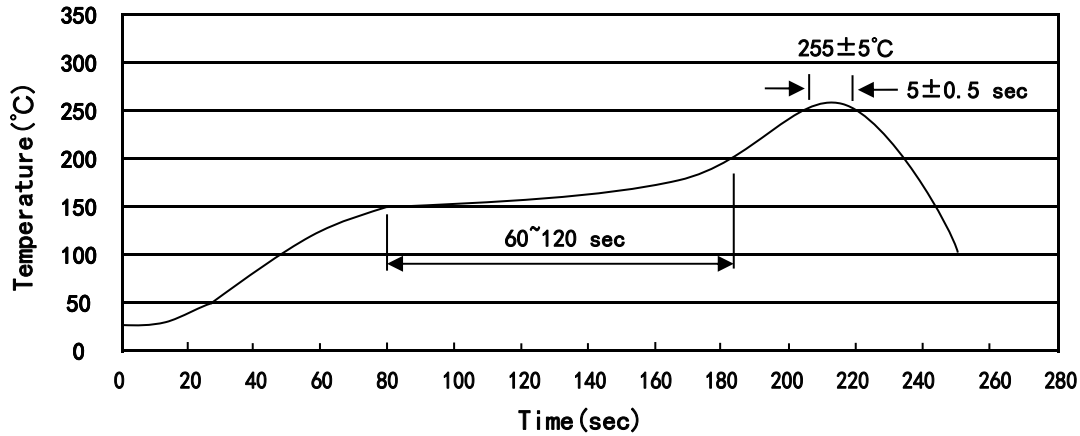

说明：

- 1、预热温度 150~200°C，时间 60~120sec;
- 2、峰值温度 255±5°C，时间持续为 5±0.5sec;
- 3、焊接制程冷却速度为 2~10°C/sec.

Note:

- 1.Preheating:150~200°C, Time:60~120sec.
- 2.Peak Temp.:255±5°C, Duration:5±0.5sec.
3. Cooling Speed: 2~10°C/sec.

耐焊接热试验条件 / Resistance to Soldering Heat Test Conditions

温度：260±5°C

时间：10±1 sec.

Temp.:260±5°C

Time:10±1 sec

包装规格 / Packaging SPEC.

卷盘包装 / REEL

Package Type 封装形式	Units 包装数量					Dimension 包装尺寸 (unit: mm ³)		
	Units/Reel 只/卷盘	Reels/Inner Box 卷盘/盒	Units/Inner Box 只/盒	Inner Boxes/Outer Box 盒/箱	Units/Outer Box 只/箱	Reel	Inner Box 盒	Outer Box 箱
PDFN5×6	5,000	2	10,000	6	60,000	13"×12	360×360×50	380×335×366

使用说明 / Notices