

BRCS100N03BD

Rev.B May.-2022

描述 / Descriptions

TO-263 塑封封装 N 沟道 MOS 场效应管。
N-CHANNEL MOSFET in a TO-263 Plastic Package.

特征 / Features

低栅电荷,低反馈电容,开关速度快,无卤产品。
Low gate charge, low crss, fast switching, HF Product.

用途 / Applications

用于高功率 DC/DC 转换和功率开关。
These devices are well suited for high efficiency switching DC/DC converters and switch mode power supplies.

内部等效电路 / Equivalent Circuit

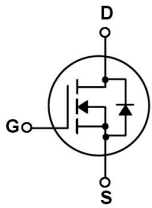

引脚排列 / Pinning



PIN 1 : G

PIN 2 : D

PIN 3 : S

PIN 4 : D

印章代码 / Marking

见印章说明。 See Marking Instructions.

极限参数 / Absolute Maximum Ratings(Ta=25°C)

参数 Parameter	符号 Symbol	数值 Rating	单位 Unit
Drain-Source Voltage	V_{DSS}	30	V
Drain Current	$I_D(T_c=25^\circ C)$	100	A
Peak Drain Current	I_{DM}	350	A
Gate-Source Voltage	V_{GSS}	± 20	V
Avalanche Current	I_{AS}	30	A
Single Pulsed Avalanche Energy	E_{AS}	360	mJ
Total Power Dissipation	$P_D(T_c=25^\circ C)$	150	W
Junction and Storage Temperature Range	T_J, T_{STG}	-55 to 150	$^\circ C$
Thermal resistance, junction - ambient	$R_{\theta JA}$	62.5	$^\circ C/W$
Thermal resistance, junction - case	$R_{\theta JC}$	0.83	

电性能参数 / Electrical Characteristics(Ta=25°C)

参数 Parameter	符号 Symbol	测试条件 Test Conditions	最小值 Min	典型值 Typ	最大值 Max	单位 Unit
Zero Gate Voltage Drain Current	I_{DSS}	$V_{GS}=0V$ $I_D=250\mu A$	30	32		V
Zero Gate Voltage Drain Current	I_{DSS}	$V_{DS}=30V$ $V_{GS}=0V$			1	μA
Gate-Body Leakage Current Forward	I_{GSS}	$V_{GS}=\pm 20V$ $V_{DS}=0V$			± 0.1	μA
Gate Threshold Voltage	$V_{GS(th)}$	$V_{DS}=V_{GS}$ $I_D=250\mu A$	1.0	1.7	3.0	V
Forward On Voltage	V_{SD}	$I_S=20A$ $V_{GS}=0V$			1.2	V
Static Drain-Source On-Resistance	$R_{DS(on)}$	$V_{GS}=10V$ $I_D=50A$		2.8	3.8	$m\Omega$
		$V_{GS}=4.5V$ $I_D=40A$		4.0	7.0	$m\Omega$
Gate resistance	R_g	$V_{GS}=0V$ $V_{DS}=0V$ $f=1MHz$		1.8		Ω
Input Capacitance	C_{iss}	$V_{GS}=0V$ $V_{DS}=25V$ $f=1.0MHz$		2500		μF
Output Capacitance	C_{oss}			310		μF
Reverse Transfer Capacitance	C_{rss}			275		μF

电性能参数 / Electrical Characteristics(Ta=25°C)

参数 Parameter	符号 Symbol	测试条件 Test Conditions	最小值 Min	典型值 Typ	最大值 Max	单位 Unit
Total Gate Charge	$Q_{g(10V)}$	$V_{GS}=10V,$ $I_D=20A$ $V_{DS}=15V,$		80		nC
Total Gate Charge	$Q_{g(4.5V)}$			35		
Gate Source Charge	Q_{gs}			13		
Gate Drain Charge	Q_{gd}			13		
Turn-On Delay Time	$t_{d(on)}$	$V_{DD}=15V$ $R_{GEN}=6\Omega$ $I_D=1A$ $V_{GS}=10V$		25.7	50	ns
Turn-On Rise Time	t_r			10	20	ns
Turn-Off Delay Time	$t_{d(off)}$			128	200	ns
Turn-Off Fall Time	t_f			34	70	ns

电参数曲线图 / Electrical Characteristic Curve

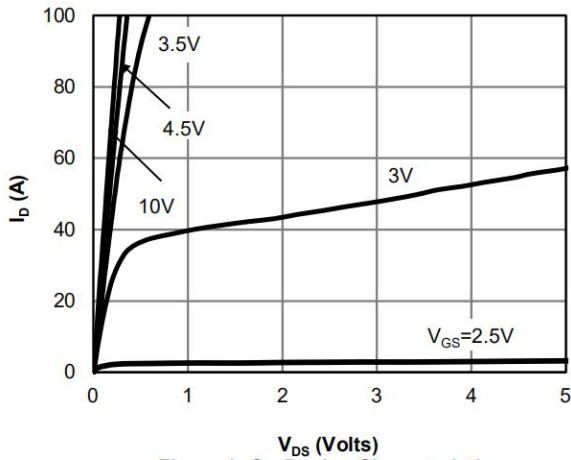

Figure 1: On-Region Characteristics

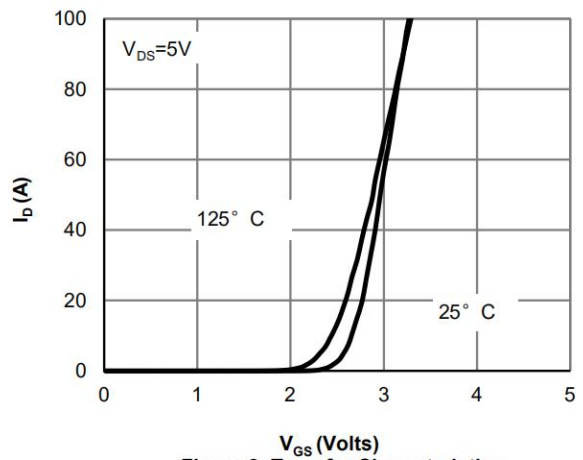

Figure 2: Transfer Characteristics

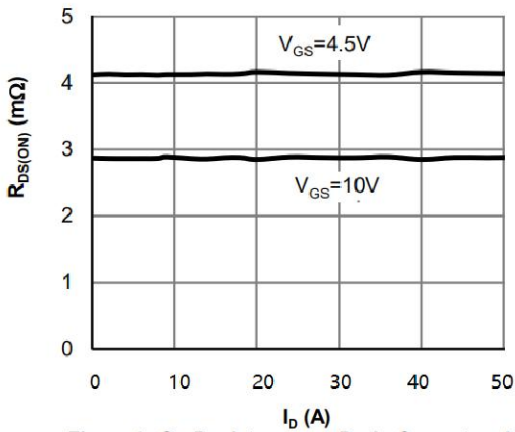

Figure 3: On-Resistance vs. Drain Current and Gate Voltage

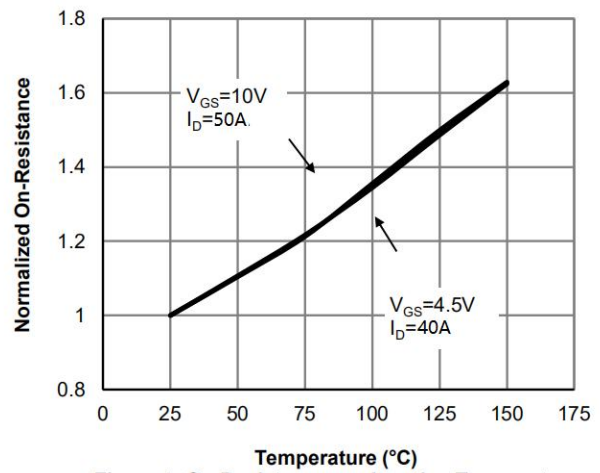

Figure 4: On-Resistance vs. Junction Temperature

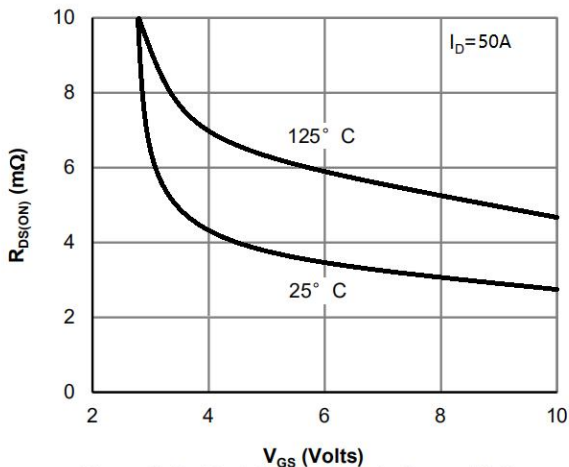

Figure 5: On-Resistance vs. Gate-Source Voltage

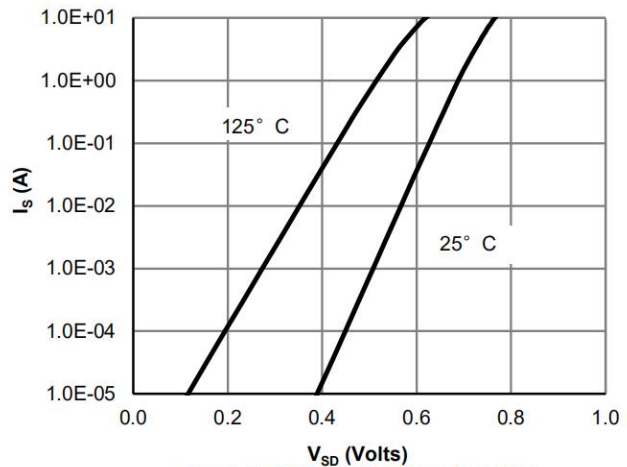

Figure 6: Body-Diode Characteristics

电参数曲线图 / Electrical Characteristic Curve

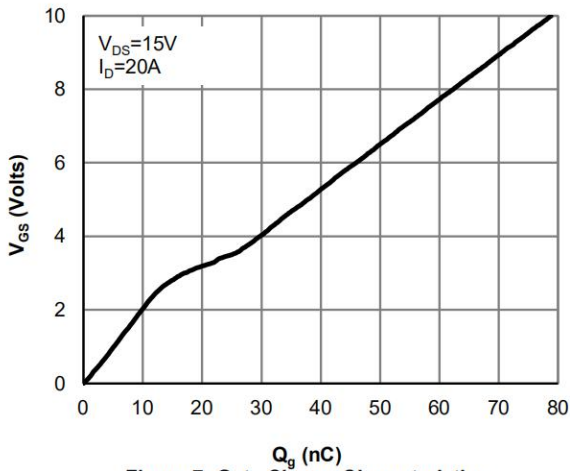

Figure 7: Gate-Charge Characteristics

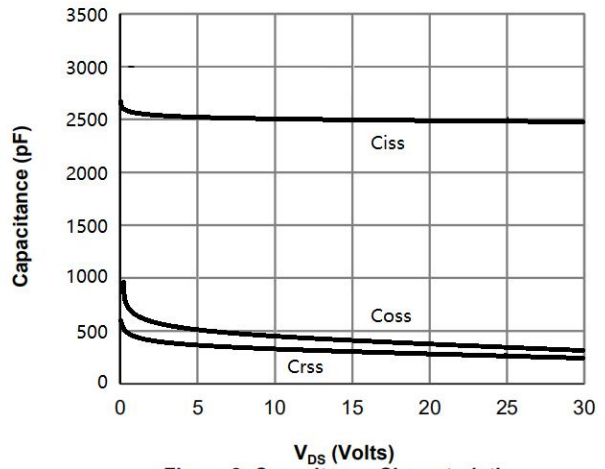

Figure 8: Capacitance Characteristics

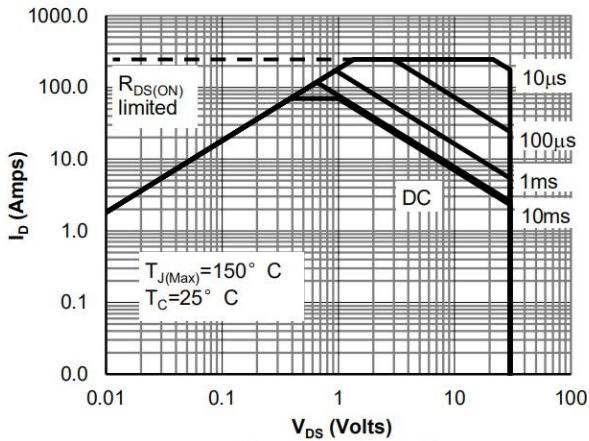

Figure 9: Maximum Forward Biased Safe Operating Area
 $V_{GS} > \text{or equal to } 4.5V$

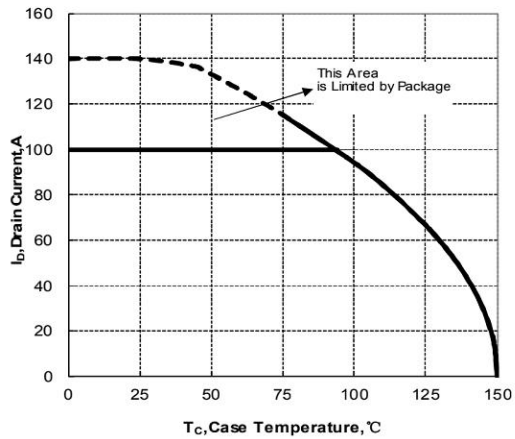

Figure 10: Maximum Continuous Drain Current vs Case Temperature

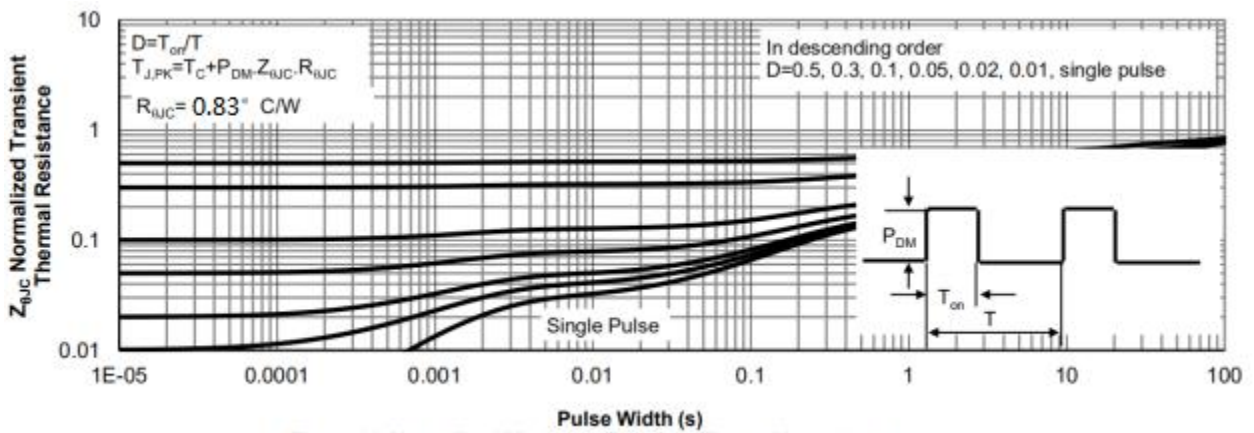
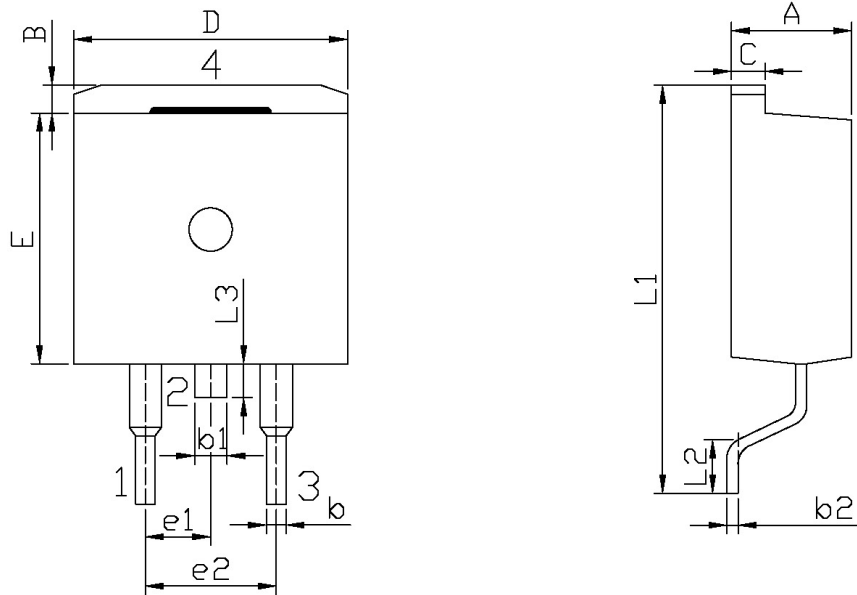

Figure 11: Normalized Maximum Transient Thermal Impedance

外形尺寸图 / Package Dimensions



单位: mm

Symbol	Dimensions In Millimeters		Symbol	Dimensions In Millimeters	
	Min	Max		Min	Max
A	4.30	4.70	E	9.00	9.40
B	1.00	1.40	e1	2.34	2.74
b	0.70	0.90	e2	4.88	5.28
b1	1.15	1.35	L1	15.00	16.00
b2	0.40	0.60	L2	2.24	2.84
C	1.20	1.40	L3	1.20	1.60
D	9.80	10.20			

T0-263

印章说明 / Marking Instructions

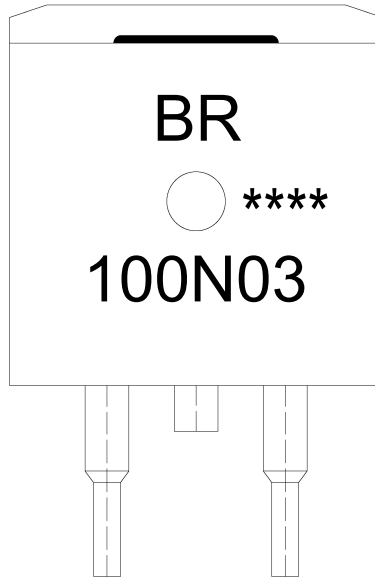

说明：

BR： 为公司代码

100N03： 为型号代码

****： 为生产批号代码，随生产批号变化

Note:

BR: Company Code

100N03: Product Type

****: Lot No. Code, code change with Lot No

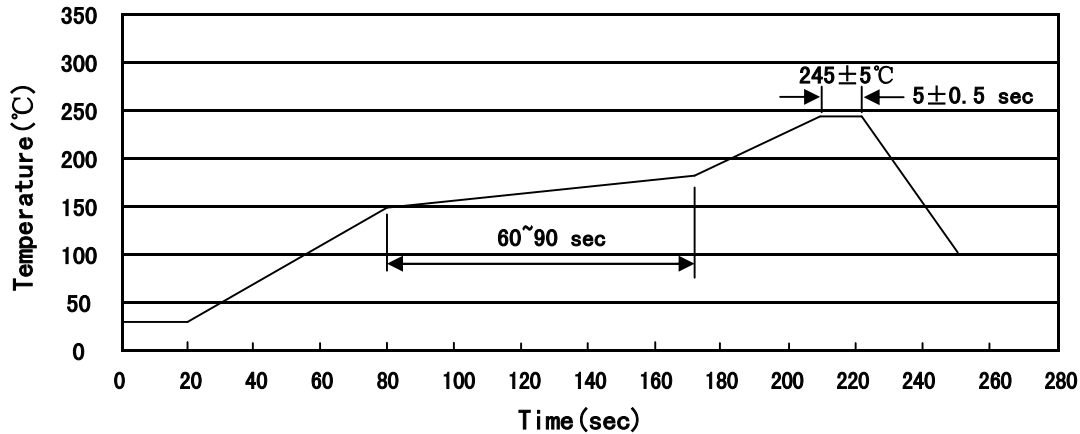
回流焊温度曲线图(无铅) / Temperature Profile for IR Reflow Soldering(Pb-Free)

说明：

- 1、预热温度 150~180°C，时间 60~90sec;
- 2、峰值温度 245±5°C，时间持续为 5±0.5sec;
- 3、焊接制程冷却速度为 2~10°C/sec.

Note:

- 1.Preheating:150~180°C, Time:60~90sec.
- 2.Peak Temp.:245±5°C, Duration:5±0.5sec.
3. Cooling Speed: 2~10°C/sec.

耐焊接热试验条件 / Resistance to Soldering Heat Test Conditions

温度：260±5°C

时间：10±1 sec.

Temp.:260±5°C

Time:10±1 sec

包装规格 / Packaging SPEC.

卷盘包装 / REEL

Package Type 封装形式	Units 包装数量					Dimension 包装尺寸 (unit: mm ³)		
	Units/Reel 只/卷盘	Reels/Inner Box 卷盘/盒	Units/Inner Box 只/盒	Inner Boxes/Outer Box 盒/箱	Units/Outer Box 只/箱	Reel	Inner Box 盒	Outer Box 箱
TO-263	800	1	800	6	4,800	13" ×24	360×360×50	380×335×366

套管包装 / TUBE

Package Type 封装形式	Units 包装数量					Dimension 包装尺寸 (unit: mm ³)		
	Units/Tube 只/套管	Tubes/Inner Box 套管/盒	Units/Inner Box 只/盒	Inner Boxes/Outer Box 盒/箱	Units/Outer Box 只/箱	Tube 套管	Inner Box 盒	Outer Box 箱
TO-263	50	20	1,000	5	5,000	532×33×7.0	555×164×50	575×290×180

使用说明 / Notices