

## 描述 / Descriptions

TO-126F 塑封封装 NPN 半导体三极管。 Silicon NPN transistor in a TO-126F Plastic Package.

## 特征 / Features

耐压高,共基极输出电容小。

High  $V_{CEO}$ , low  $C_{ob}$ .

## 用途 / Applications

用于彩电色度输出。

Video output amplifier.

## 内部等效电路 / Equivalent Circuit



## 引脚排列 / Pinning



PIN1 : Emitter

PIN 2 : Collector

PIN 3 : Base

## 放大及印章代码 / $h_{FE}$ Classifications & Marking

见印章说明。 See Marking Instructions.

**极限参数 / Absolute Maximum Ratings(Ta=25°C)**

参数 Parameter	符号 Symbol	数值 Rating	单位 Unit
Collector to Base Voltage	$V_{CBO}$	300	V
Collector to Emitter Voltage	$V_{CEO}$	300	V
Emitter to Base Voltage	$V_{EBO}$	7.0	V
Collector Current - Continuous	$I_C$	100	mA
Collector Current – Continuous(Pulse)	$I_{CP}$	200	mA
Collector Power Dissipation	$P_C$	1.2	W
Junction Temperature	$T_j$	150	°C
Storage Temperature Range	$T_{stg}$	-55~150	°C

**电性能参数 / Electrical Characteristics(Ta=25°C)**

参数 Parameter	符号 Symbol	测试条件 Test Conditions	最小值 Min	典型值 Typ	最大值 Max	单位 Unit
Collector to Base Breakdown Voltage	$V_{CBO}$	$I_C=10\mu A$ $I_E=0$	300			V
Collector to Emitter Breakdown Voltage	$V_{CEO}$	$I_C=0.1mA$ $I_B=0$	300			V
Emitter to Base Breakdown Voltage	$V_{EBO}$	$I_E=10\mu A$ $I_C=0$	7.0			V
DC Current Gain	$h_{FE}$	$V_{CE}=50V$ $I_C=5.0mA$	50		250	
Collector to Emitter Saturation Voltage	$V_{CE(sat)}$	$I_C=30mA$ $I_B=3.0mA$			1.5	V
Base to Emitter Voltage	$V_{BE}$	$V_{CE}=10V$ $I_C=30mA$			1.2	V
Transition Frequency	$f_T$	$V_{CB}=30V$ $I_C=20mA$	70	140		MHz
Collector Output Capacitance	$C_{ob}$	$V_{CB}=30V$ $I_E=0$ $f=1.0MHz$		2.4		pF

电参数曲线图 / Electrical Characteristic Curve

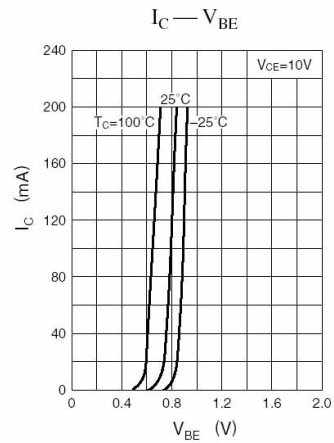
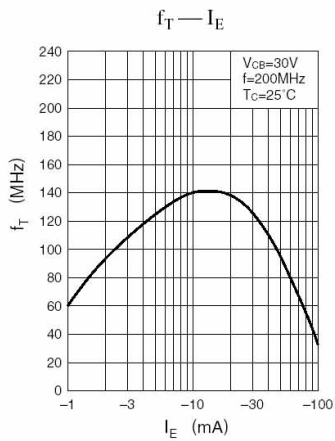
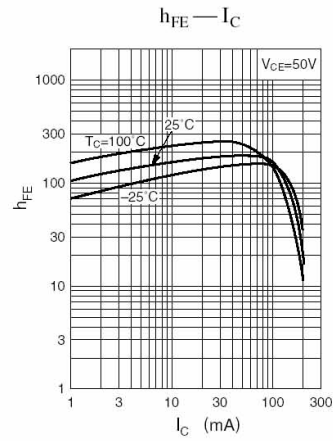
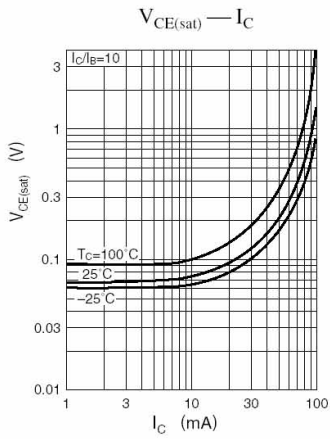
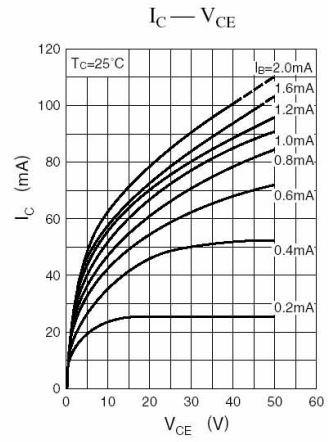
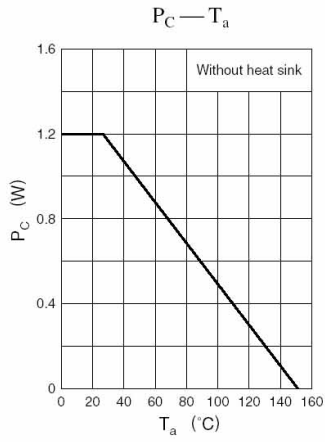

外形尺寸图 / Package Dimensions

T0-126F

单位: mm

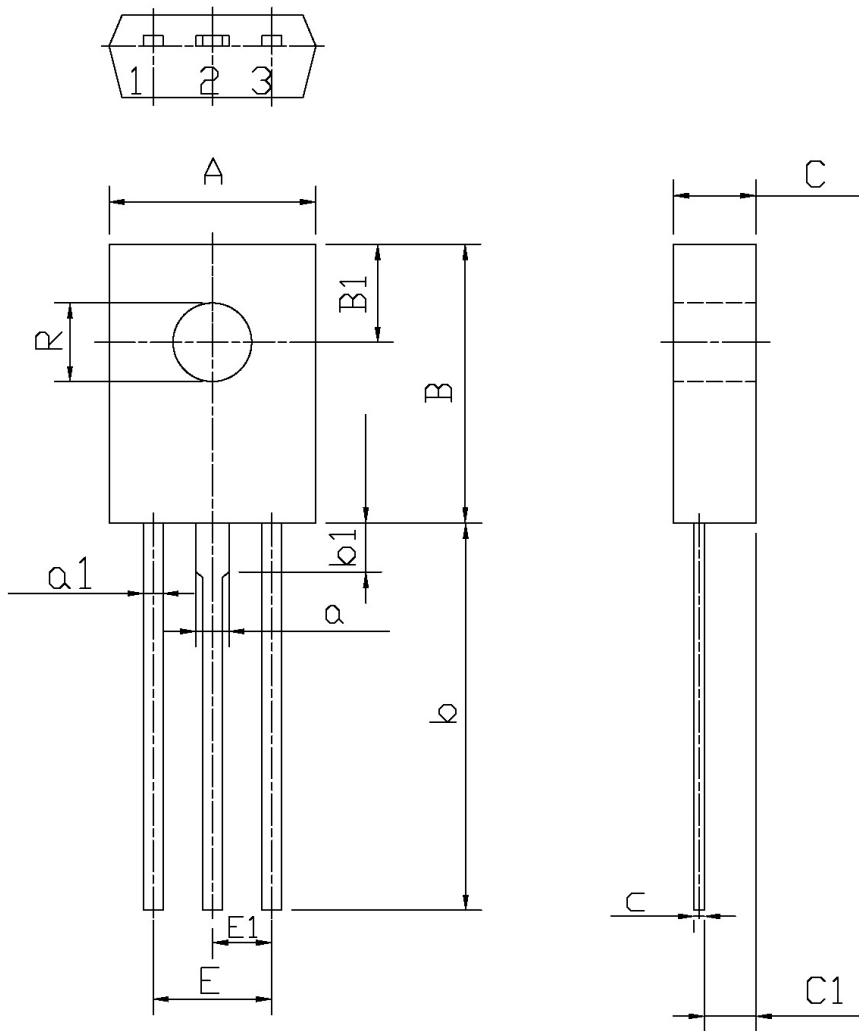

Symbol	Dimensions In Millimeters		Symbol	Dimensions In Millimeters	
	Min	Max		Min	Max
A	7.8	8.2	a1	0.66	0.86
B	10.8	11.2	E	4.4	4.8
B1	3.8	4.2	C	3.1	3.3
R	2.95	3.15	C1	1.9	2.1
b	14	16	c	0.3	0.6
b1	1.9		a	1.27	
E1	2.1	2.5			

印章说明 / Marking Instructions

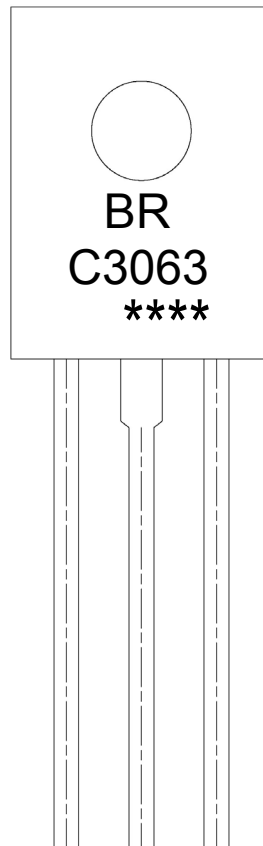

说明：

BR： 为公司代码

C3063： 为型号代码

\*\*\*\*： 为生产批号代码，随生产批号变化。

Note:

BR: Company Code

C3063: Product Type.

\*\*\*\*: Lot No. Code, code change with Lot No.

**波峰焊温度曲线图(无铅) / Temperature Profile for Dip Soldering(Pb-Free)**



说明：

- 1、预热温度 25 ~ 150°C，时间 60 ~ 90sec；
- 2、峰值温度 255±5°C，时间持续为 5±0.5sec；
- 3、焊接制程冷却速度为 2 ~ 10°C/sec.

Note:

- 1.Preheating:25~150°C, Time:60~90sec.
- 2.Peak Temp.:255±5°C, Duration:5±0.5sec.
3. Cooling Speed: 2~10°C/sec.

**耐焊接热试验条件 / Resistance to Soldering Heat Test Conditions**

温度：270±5°C

时间：10±1 sec.

Temp.:270±5°C

Time:10±1 sec

**包装规格 / Packaging SPEC.**

散件包装 / BULK

Package Type 封装形式	Units 包装数量					Dimension 包装尺寸 (unit: mm <sup>3</sup> )		
	Units/Tube 只/套管	Tubes/Inner Box 套管/盒	Units/Inner Box 只/盒	Inner Boxes/Outer Box 盒/箱	Units/Outer Box 只/箱	Tube 套管	Inner Box 盒	Outer Box 箱
TO-126/F	500	6	3,000	5	15,000	135×190	237×172×102	560×245×195

套管包装 / TUBE

Package Type 封装形式	Units 包装数量					Dimension 包装尺寸 (unit: mm <sup>3</sup> )		
	Units/Tube 只/套管	Tubes/Inner Box 套管/盒	Units/Inner Box 只/盒	Inner Boxes/Outer Box 盒/箱	Units/Outer Box 只/箱	Tube 套管	Inner Box 盒	Outer Box 箱
TO-126/F	65	26	1,690	5	8,450	532×31×5.6	555×164×50	575×290×180

**使用说明 / Notices**